

ELEKTRİK MOTOR KÖMÜRLERİ CARBON BRUSH

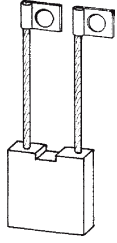

16.001

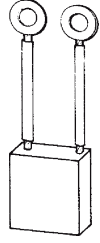

16.002

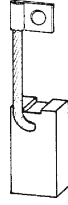

16.003

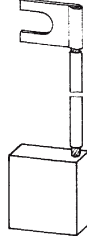

16.004

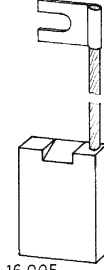

16.005

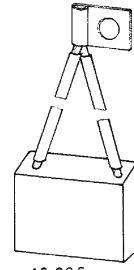

16.006

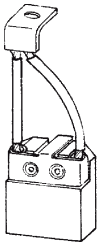

16.009

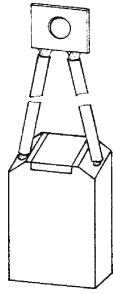

16.010

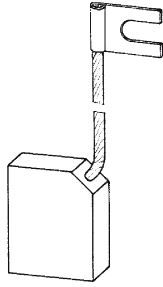

16.011

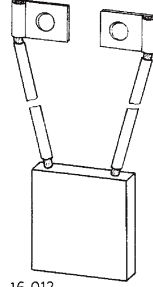

16.012

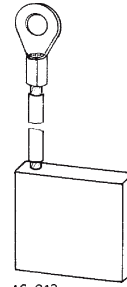

16.013

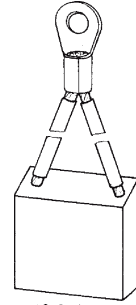

16.014

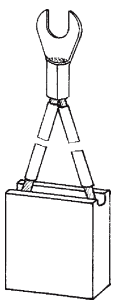

16.015

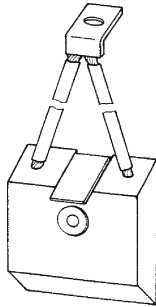

16.016

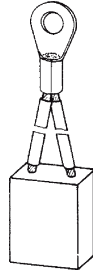

16.017

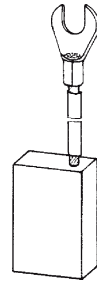

16.018

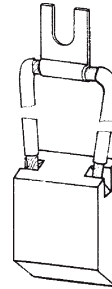

16.019

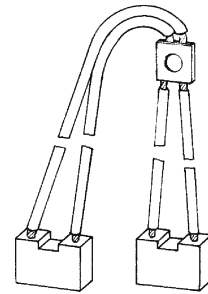

16.020

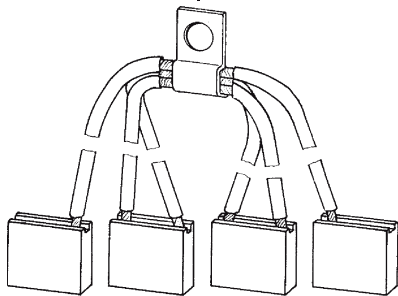

16.021

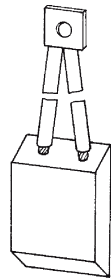

16.022

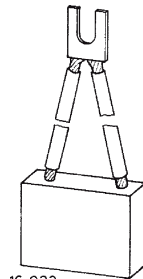

16.023

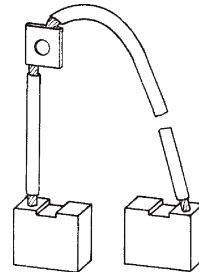

16.024

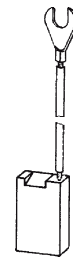

16.025



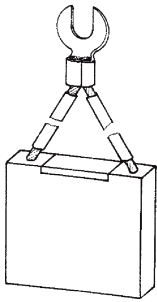

16.026



16.027

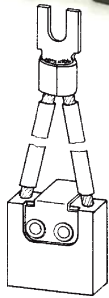

16.028

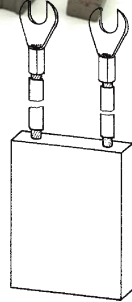

16.029

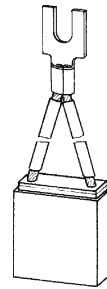

16.030

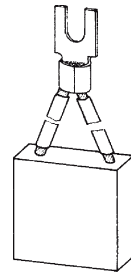

16.031

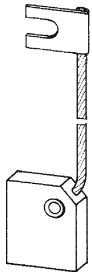

16.032

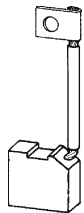

16.033

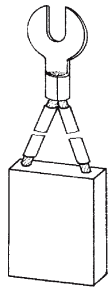

16.034

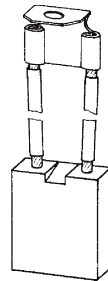

16.035

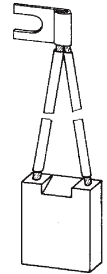

16.036

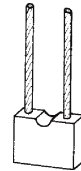

16.037

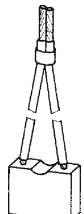

16.038

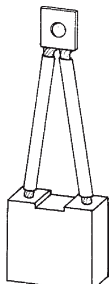

16.039

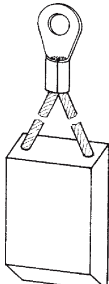

16.040

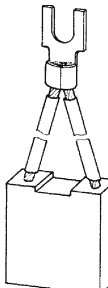

16.041

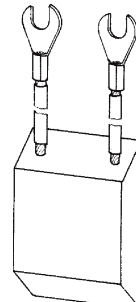

16.042

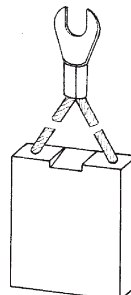

16.043

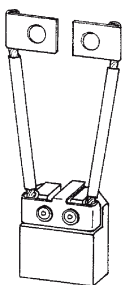

16.044

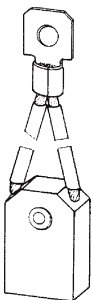

16.045

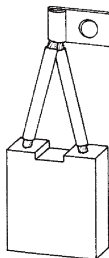

16.046

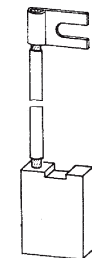

16.047

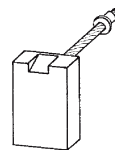

16.048

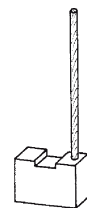

16.049



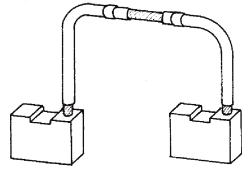

16.050

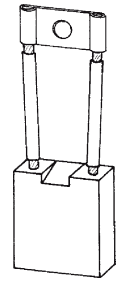

16.051

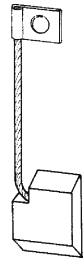

16.052

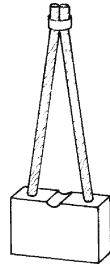

16.053



16.054

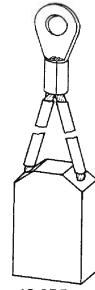

16.055

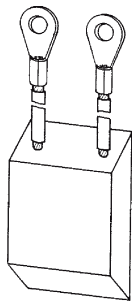

16.056

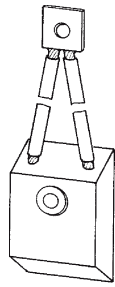

16.057

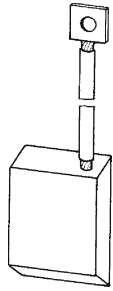

16.058

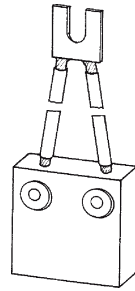

16.059

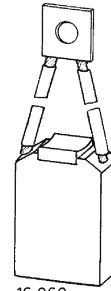

16.060

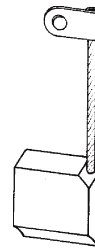

16.061



16.062

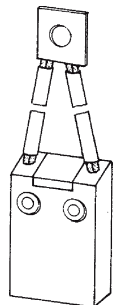

16.063

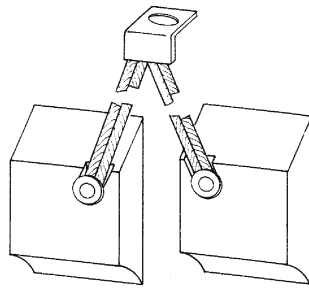

16.064

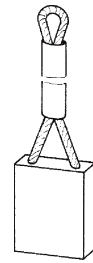

16.065



16.066



16.067

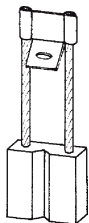

16.068



16.069



16.070

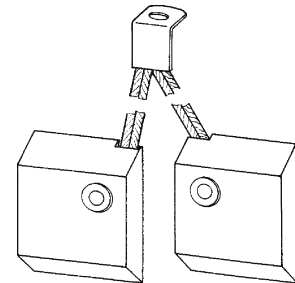

16.071



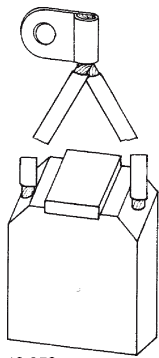

16.072

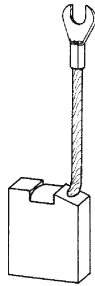

16.074

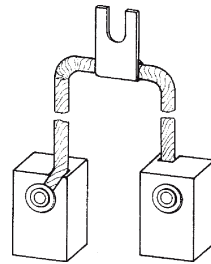

16.075

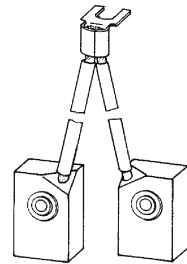

16.076

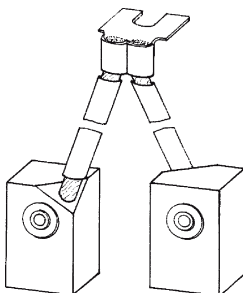

16.077

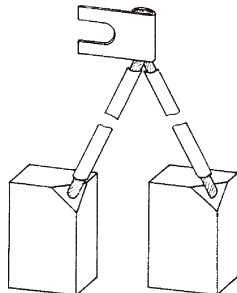

16.078

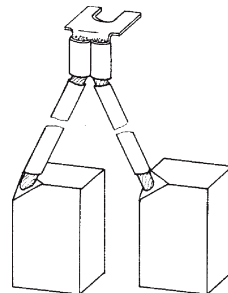

16.079

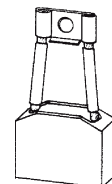

16.080

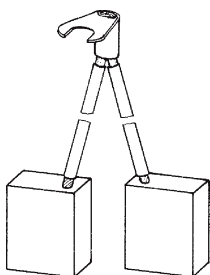

16.081

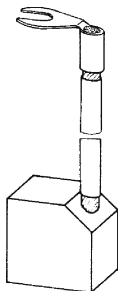

16.082

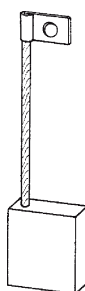

16.083

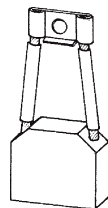

16.084

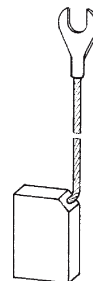

16.085

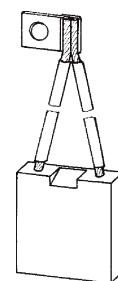

16.086

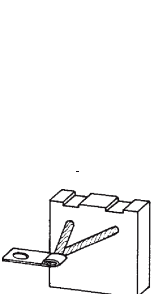

16.087

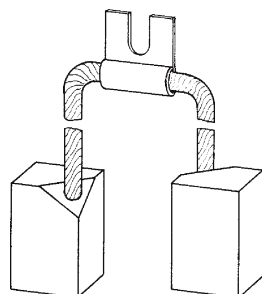

16.088

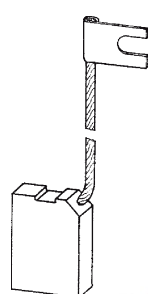

16.089

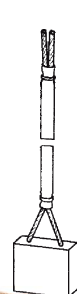

16.090

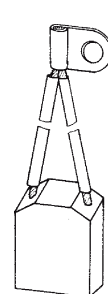

16.091

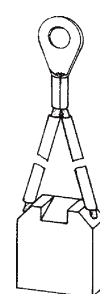

16.092

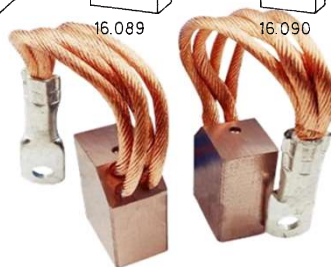

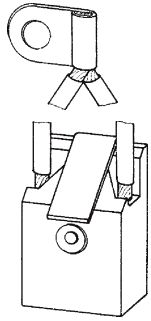

16.099

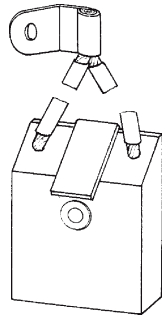

16.094

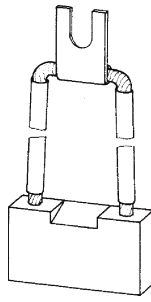

16.095

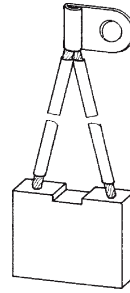

16.096

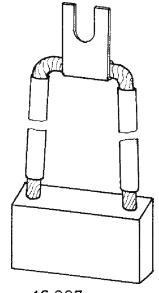

16.097

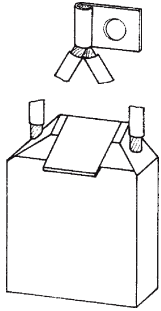

16.093

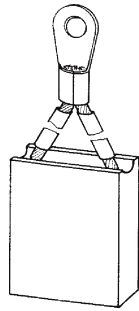

16.105

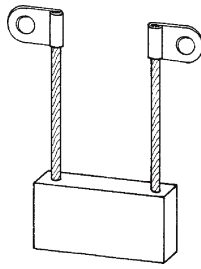

16.102



16.101

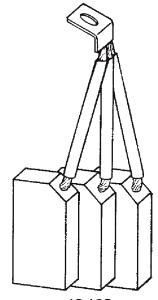

16.103

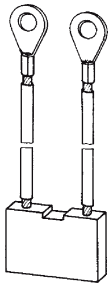

16.104

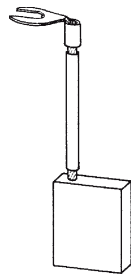

16.100

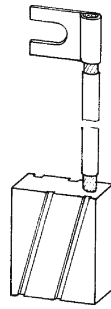

16.111

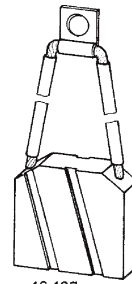

16.107

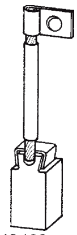

16.108

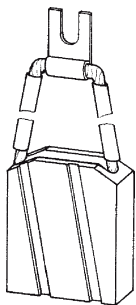

16.109

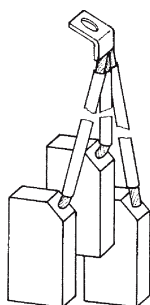

16.110

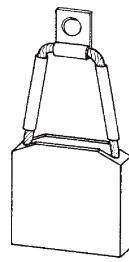

16.106

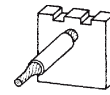

16.115

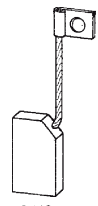

16.113

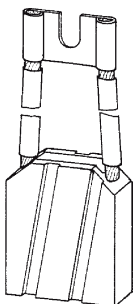

16.114

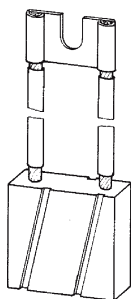

16.112

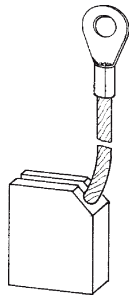

16.124



16.117

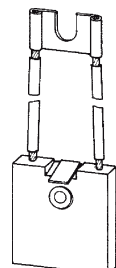

16.118

8X12X70

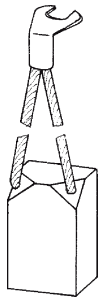

16.119

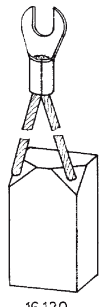

16.120

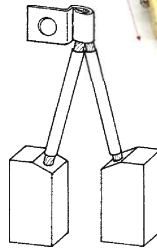

16.121

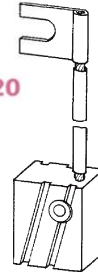

16.122

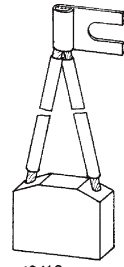

16.116

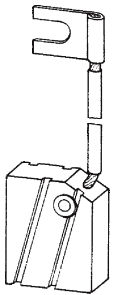

16.130

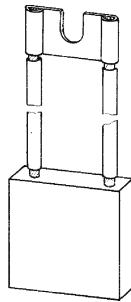

16.126

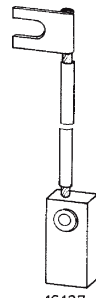

16.127

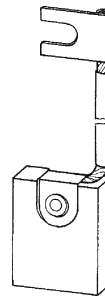

16.128

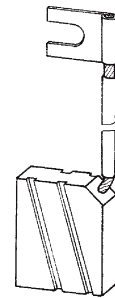

16.129

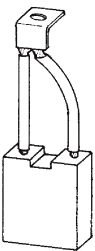

16.125

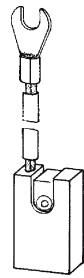

16.136

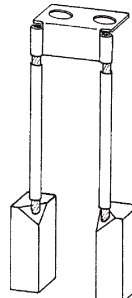

16.132

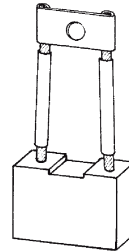

16.133

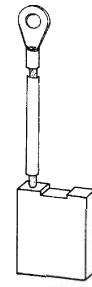

16.134

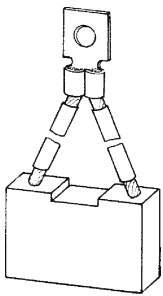

16.135

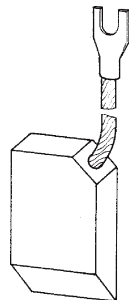

16.131

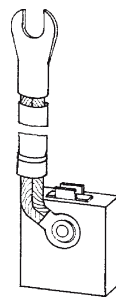

16.139

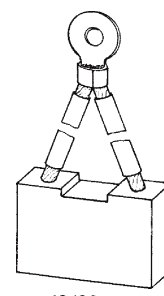

16.138

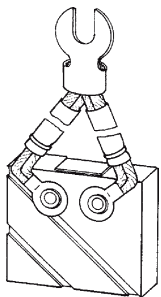
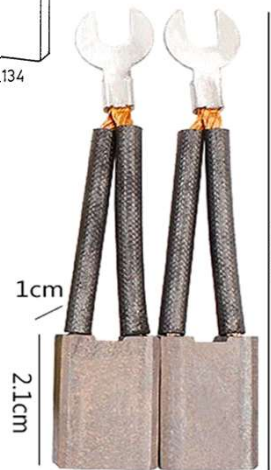

16.137

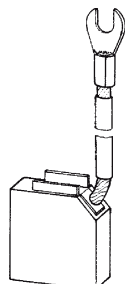

16.145

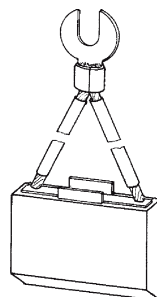

16.141

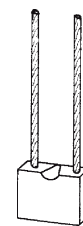

16.142

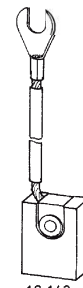

16.143

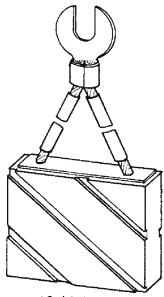

16.144

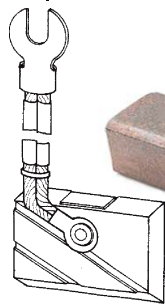

16.140

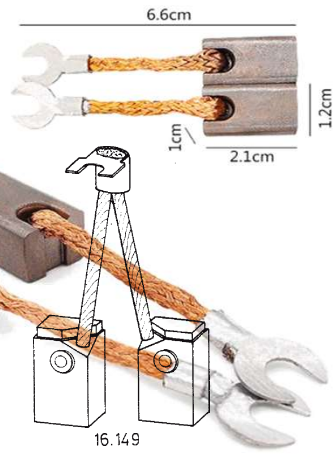

16.149

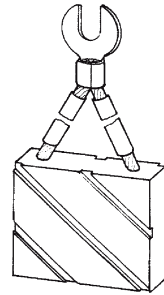

16.147

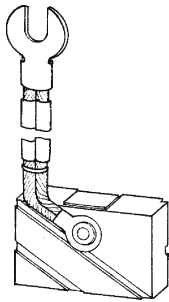

16.148

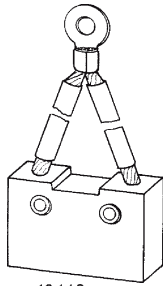

16.146

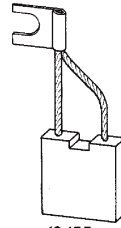

16.155

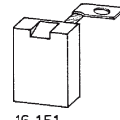

16.151

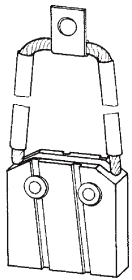

16.152

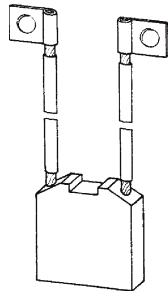

16.153

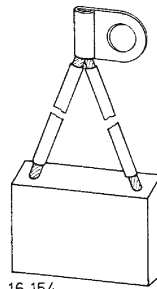

16.154

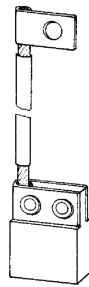

16.150

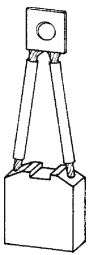

16.163

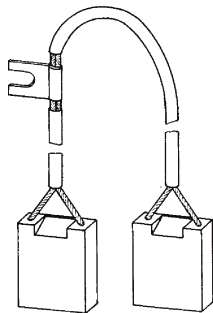

16.157

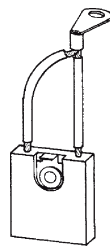

16.158

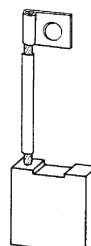

16.159

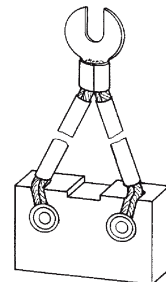

16.160

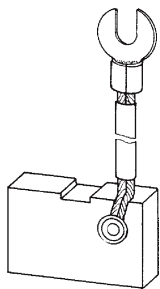

16.161

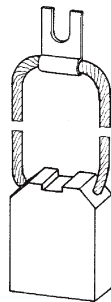

16.162

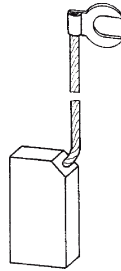

16.156

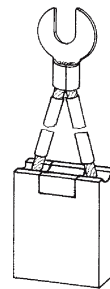

16.169

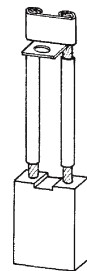

16.165

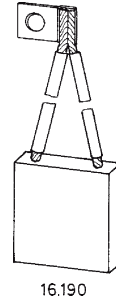
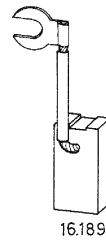
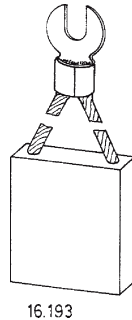
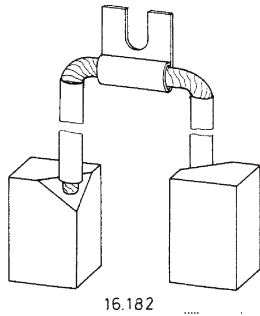
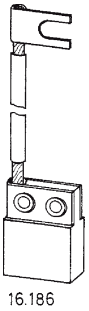
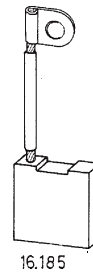
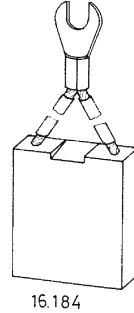
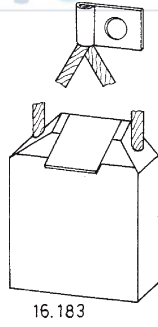
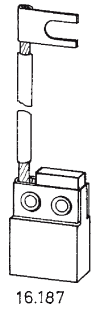
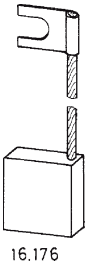
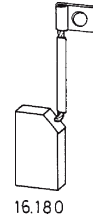
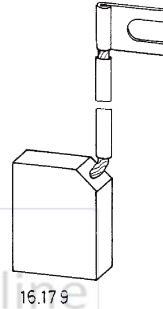
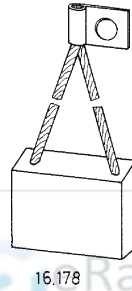
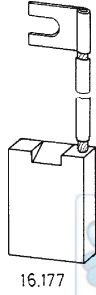
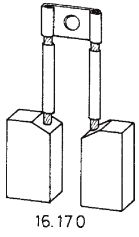
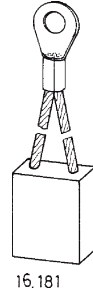
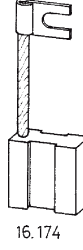
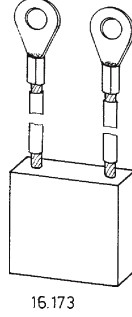
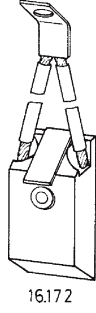
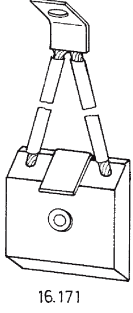
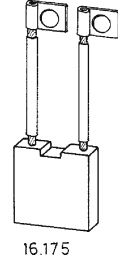
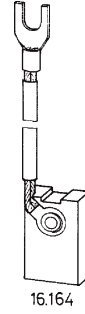
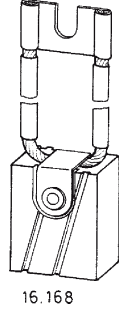
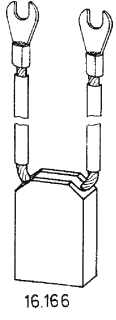

ELEKTRİK MOTOR KÖMÜRLERİ
JENERATÖR KÖMÜRLERİ
VİNÇ KÖMÜRLERİ

CARBON BRUSHES
DC MOTOR BRUSH
GENERATOR BRUSH

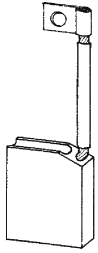

16.191

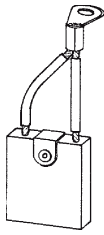

16.192

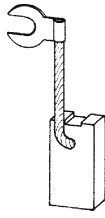

16.188

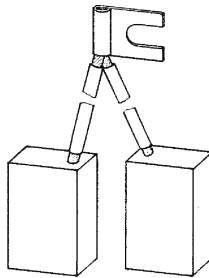

16.199

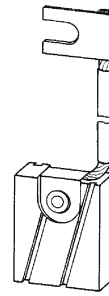

16.195

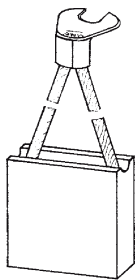

16.196

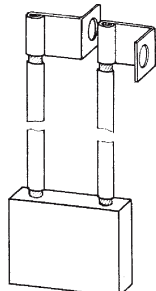

16.197

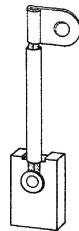

16.198

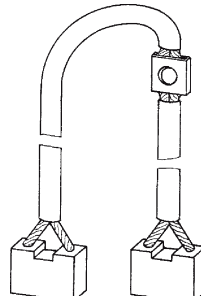

16.194

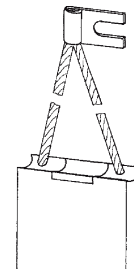

16.205

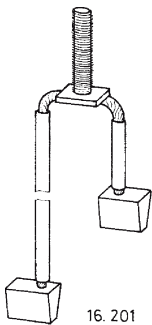

16.201

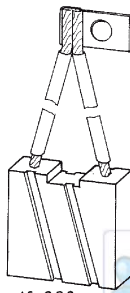

16.202

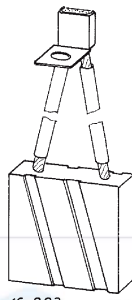

16.203

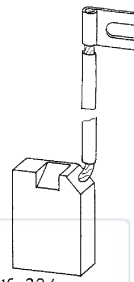

16.204

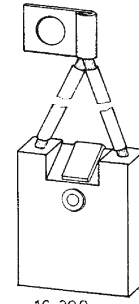

16.200

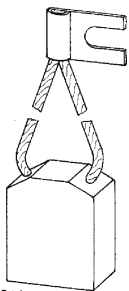

16.211

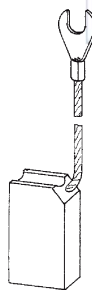

16.207

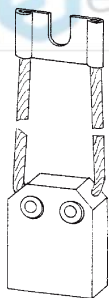

16.208

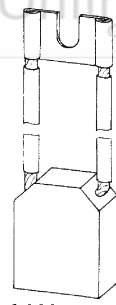

16.209

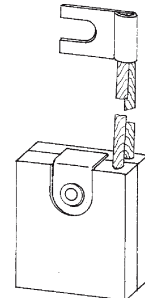

16.210

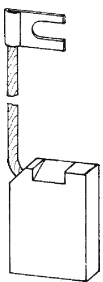

16.217

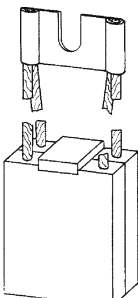

16.213

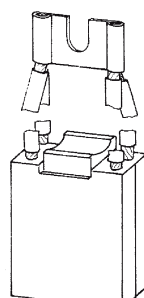

16.214

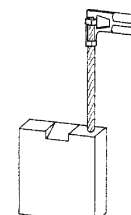

16.206

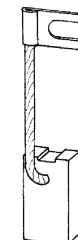

16.215

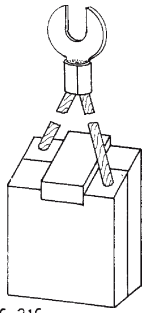

16.216

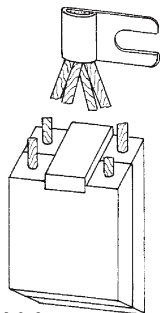

16.212

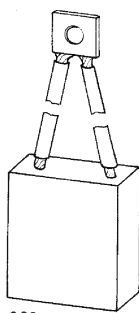

16.223

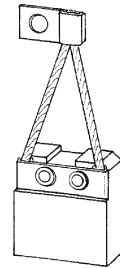

16.219

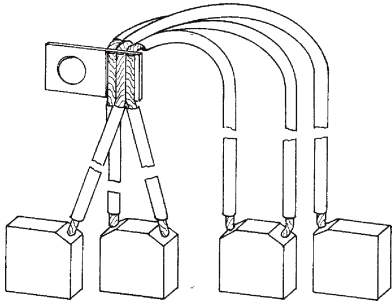

16.220

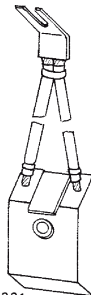

16.221

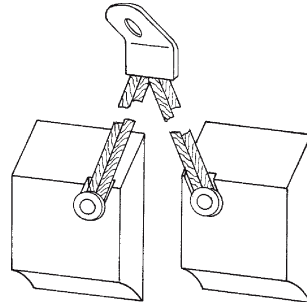

16.222

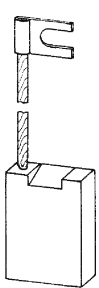

16.218

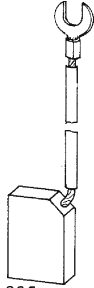

16.225

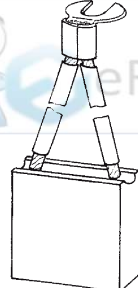
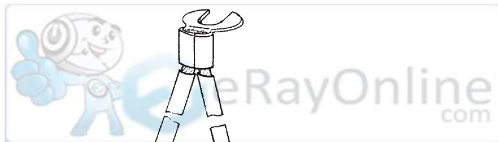

16.224

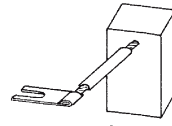

16.226

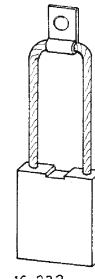

16.232

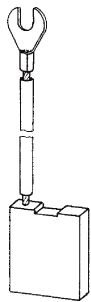

16.228

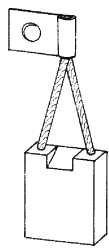

16.229

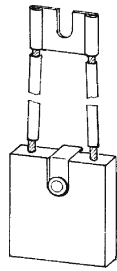

16.230

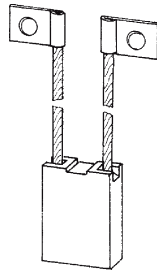

16.231

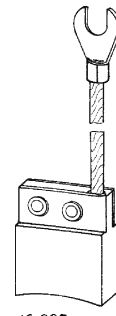

16.227

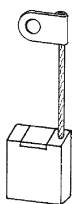

16.238

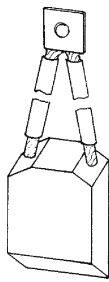

16.234

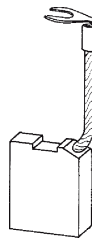

16.235

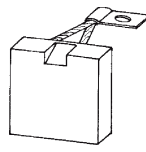

16.236

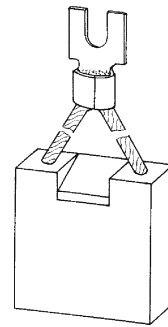

16.237

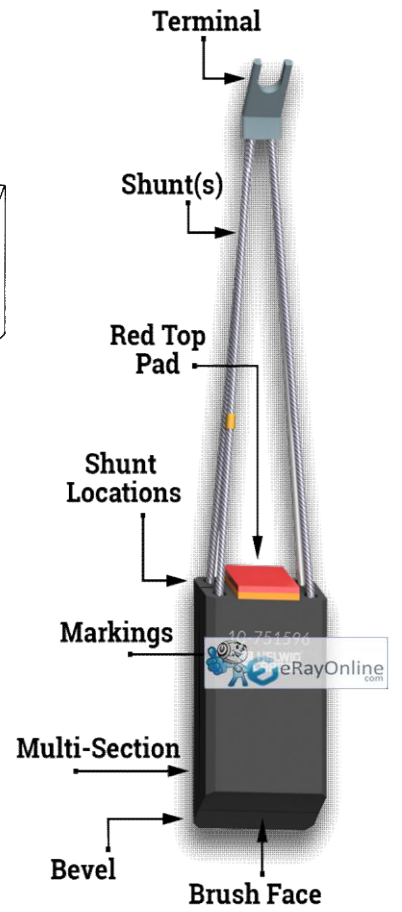
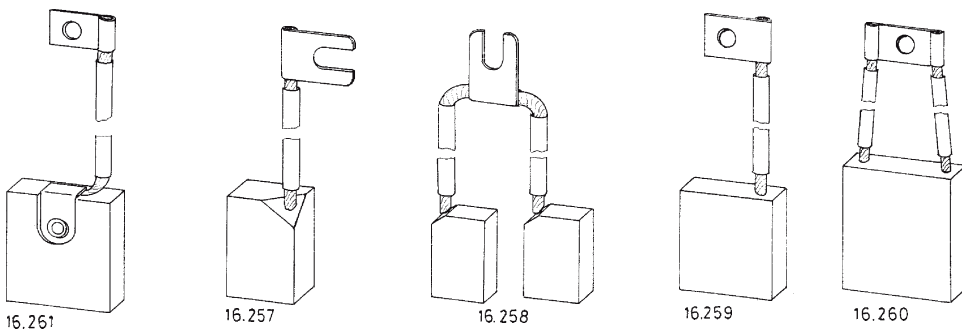
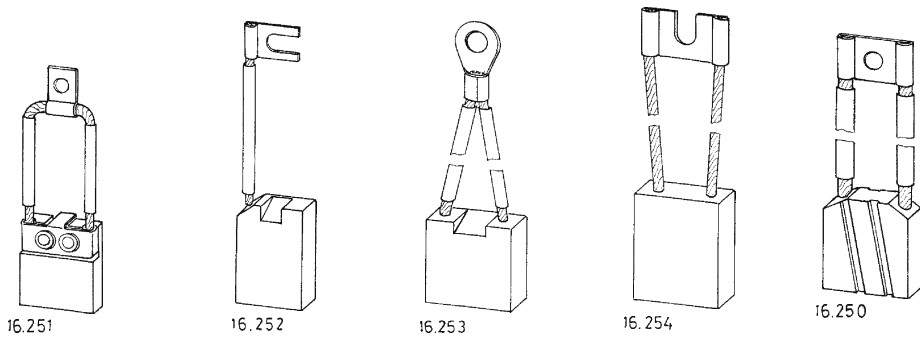
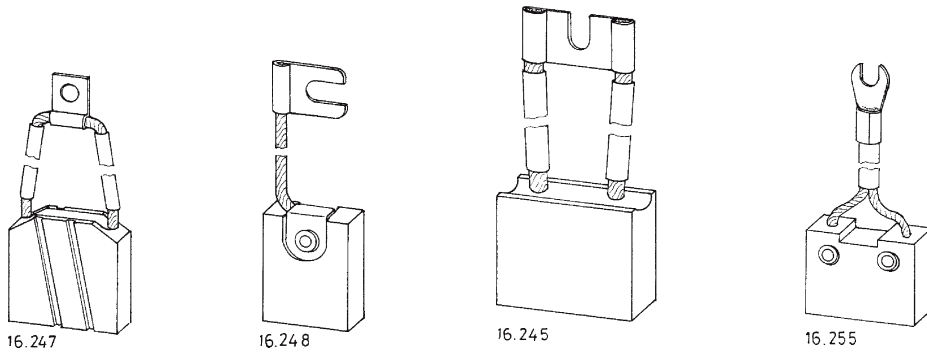
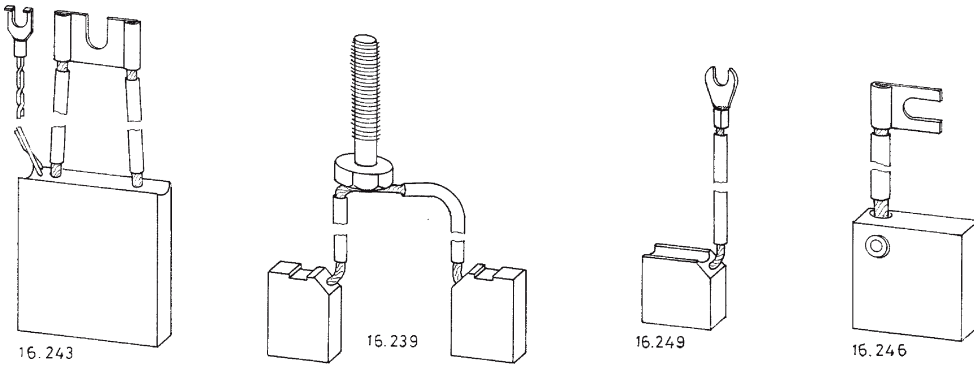
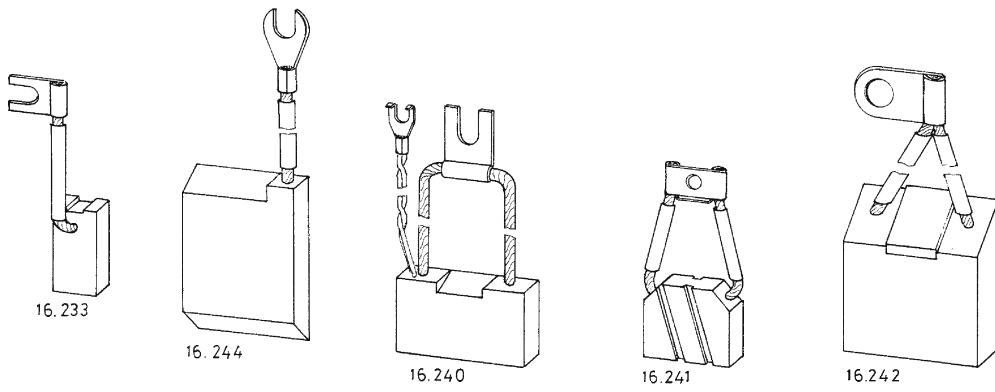

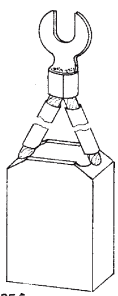

16.256

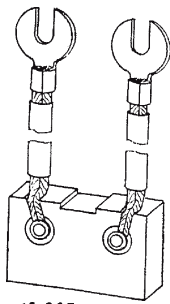

16.267

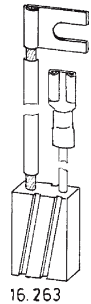

16.263

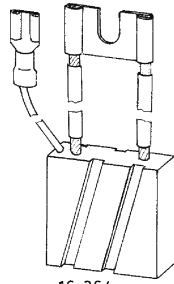

16.264

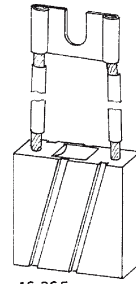

16.265

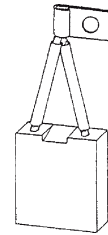

16.287

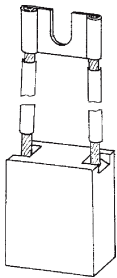

16.266

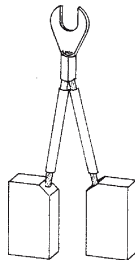

16.262

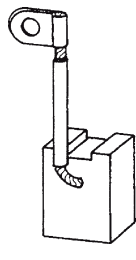

16.273

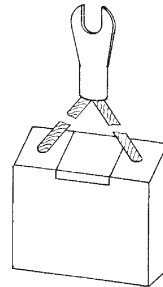

16.269

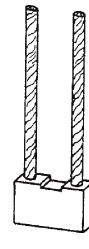

16.270

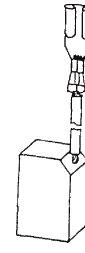

16.291

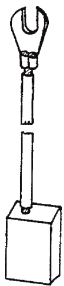

16.271

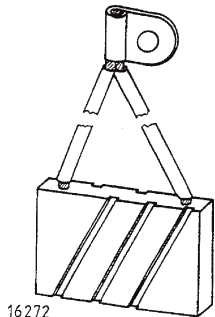

16.272

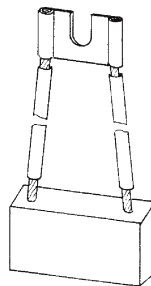

16.268

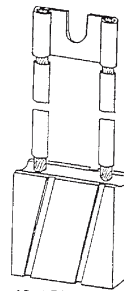

16.279

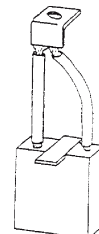

16.280

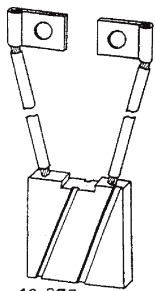

16.275



16.276

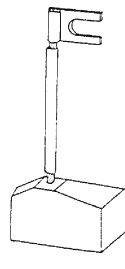

16.277

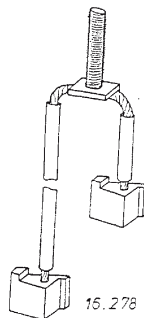

16.278

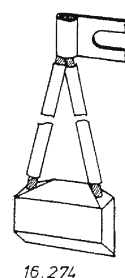

16.274

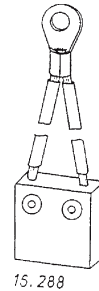

16.288

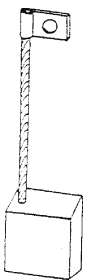

16.281

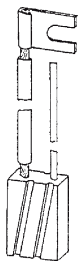

16.285

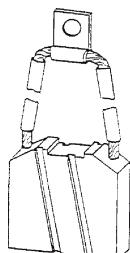

16.282

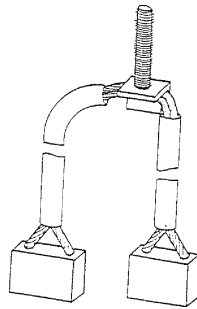

16.283

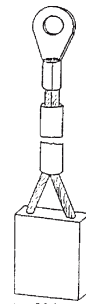

16.284



16.289

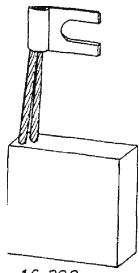

16.290

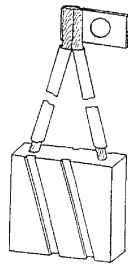

16.286

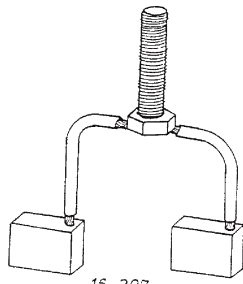

16.297

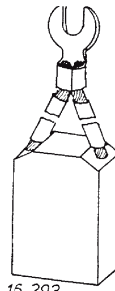

16.293

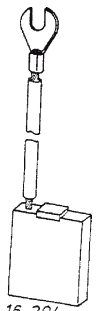

16.294

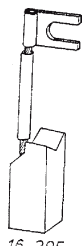

16.295

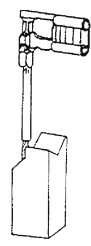

16.296

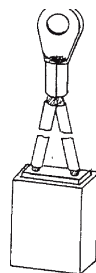

16.292

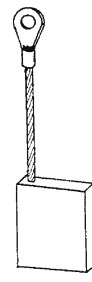

16.303

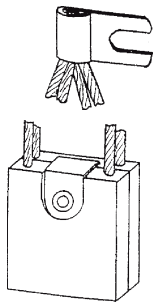

16.299

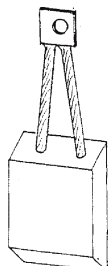

16.298

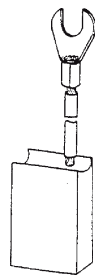

16.301

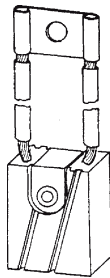

16.302

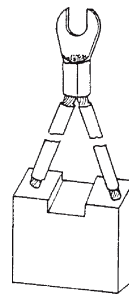

16.300

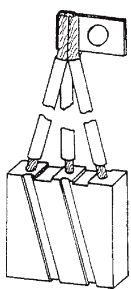

16.309

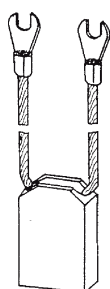

16.305

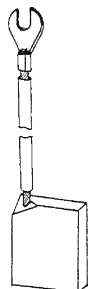

16.306

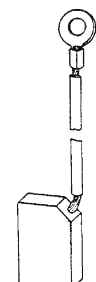

16.307

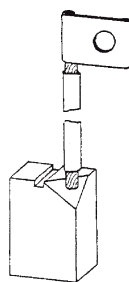

16.308

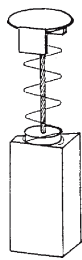

16.304

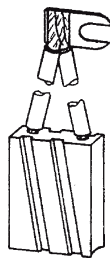

16.315

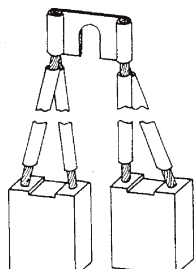

16.311

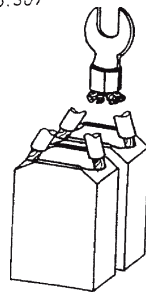

16.312

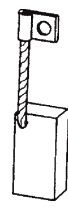

16.313

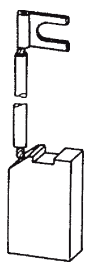

16.314

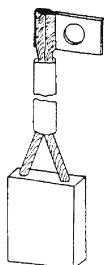

16.310

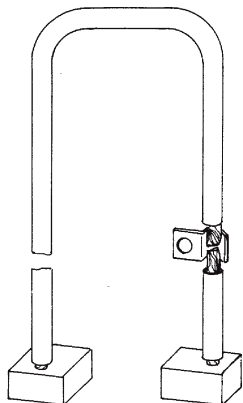

16.322

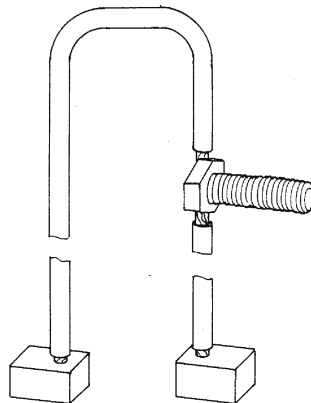

16.323

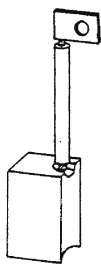

16.317

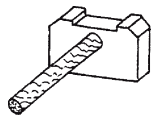

16.318

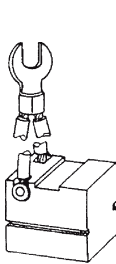

16.320

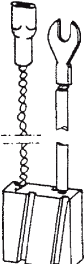

16.321

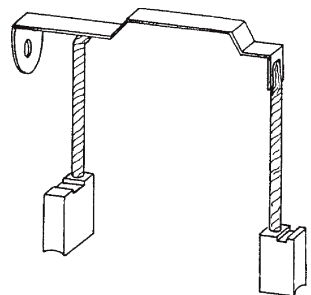

16.316

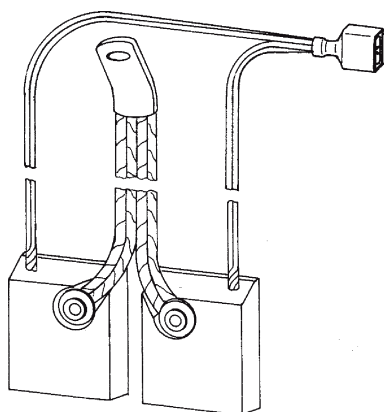

16.325

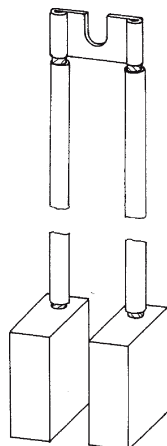

16.324

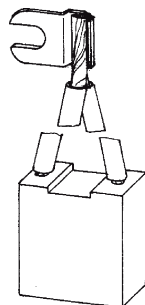

16.332

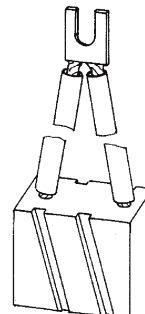

16.327

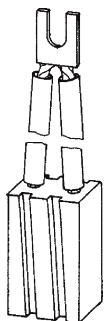

16.328

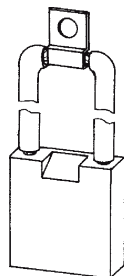

16.329

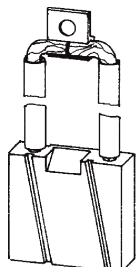

16.330

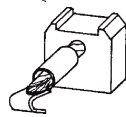

16.326

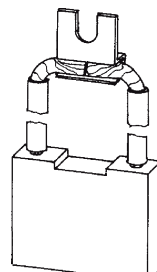

16.331



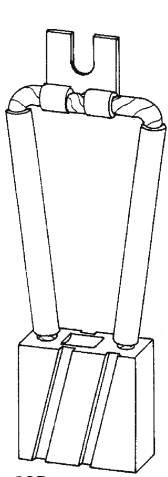

16.337

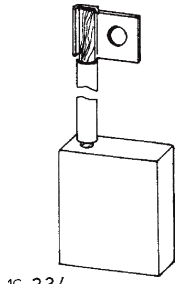

16.334

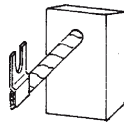

16.335

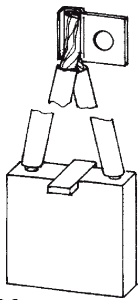

16.333

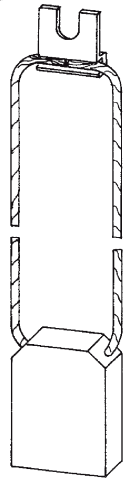

16.339

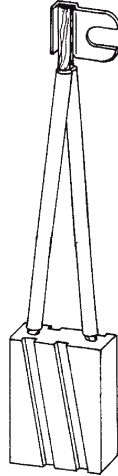

16.340

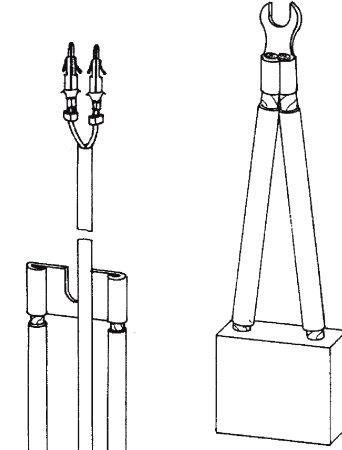

16.336

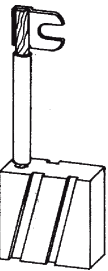

16.345

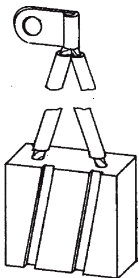

16.343

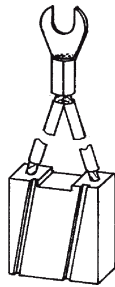

16.344

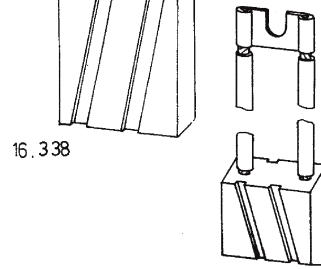

16.338

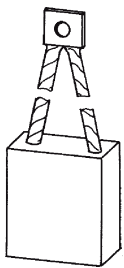

16.342

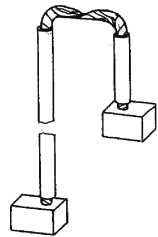

16.349

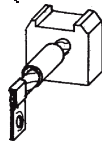

16.346

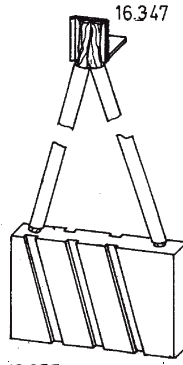

16.355

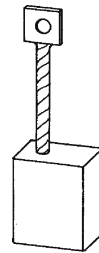

16.341

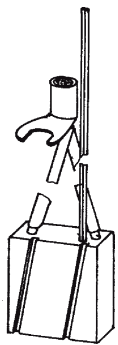

16.351

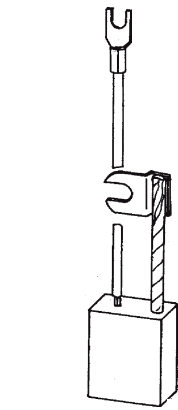

16.352

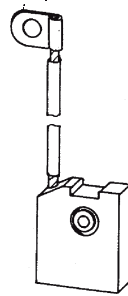

16.353

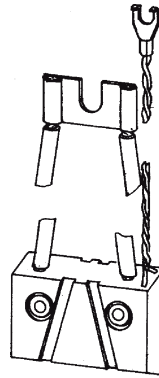

16.354



16.348

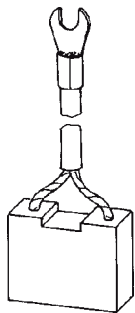
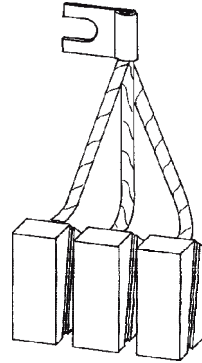
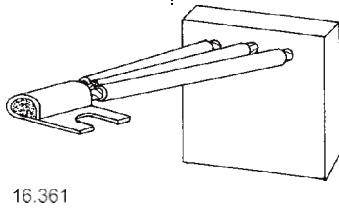
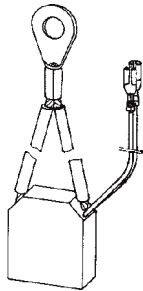
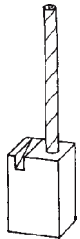
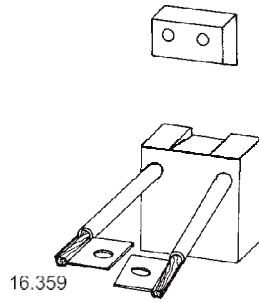
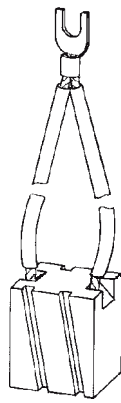
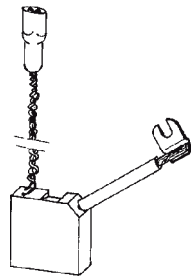
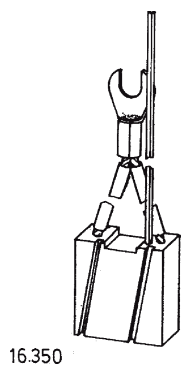

16.366

